



GYRO TECH™

by NABCO Entrances Inc.

Where quality and service are automatic

WWW.NABCOENTRANCES.COM

1-877-622-2694

JOB NAME: _____

LOCATION: _____

DISTRIBUTOR: _____

DOOR #: _____ DATE: _____

SHEET _____ OF _____

GT8300-02L
SIDELOAD HEADER
CENTER PIVOT
LEFT HAND
OUTSWING

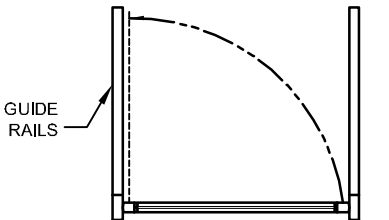
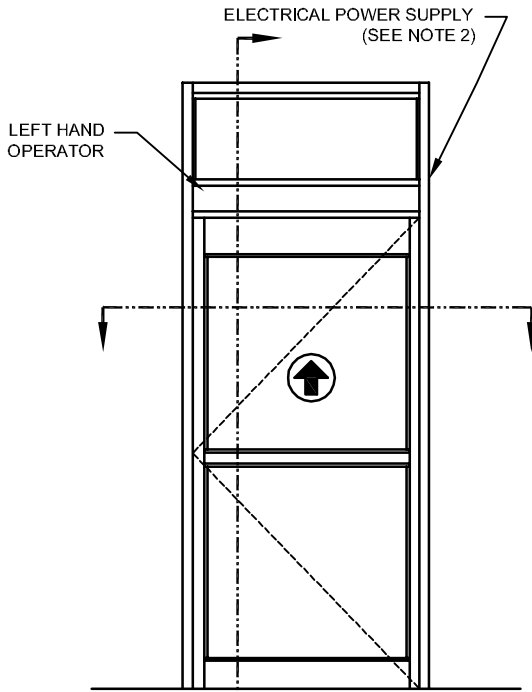

INTERIOR ELEVATION/PLAN

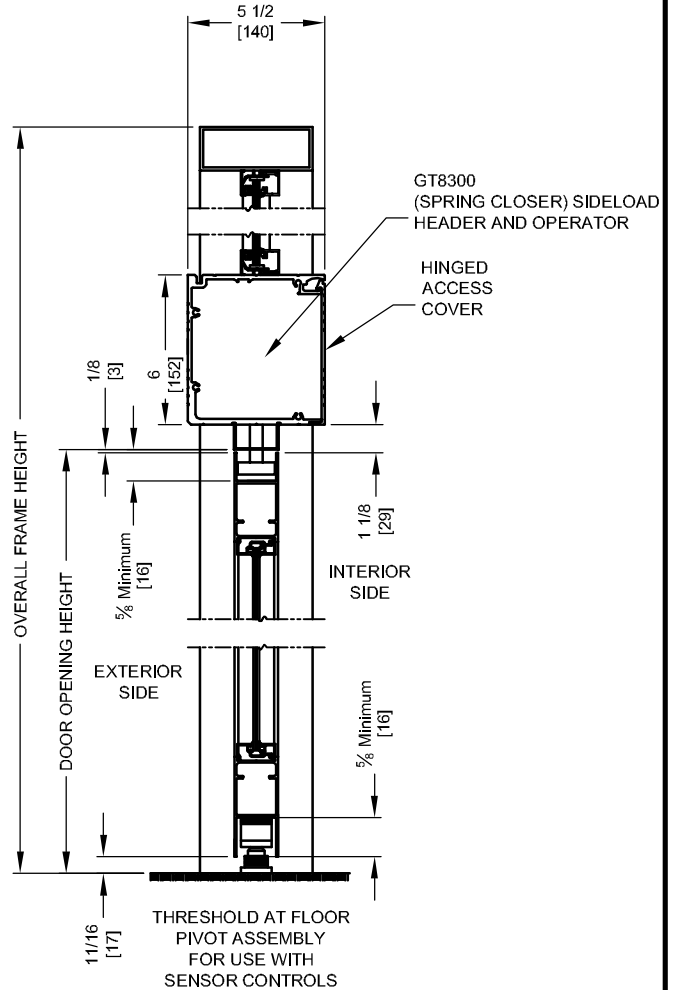
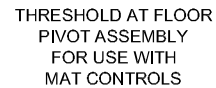
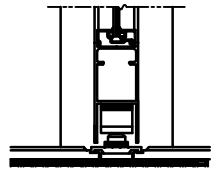
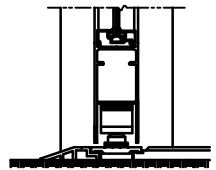

VERTICAL SECTION

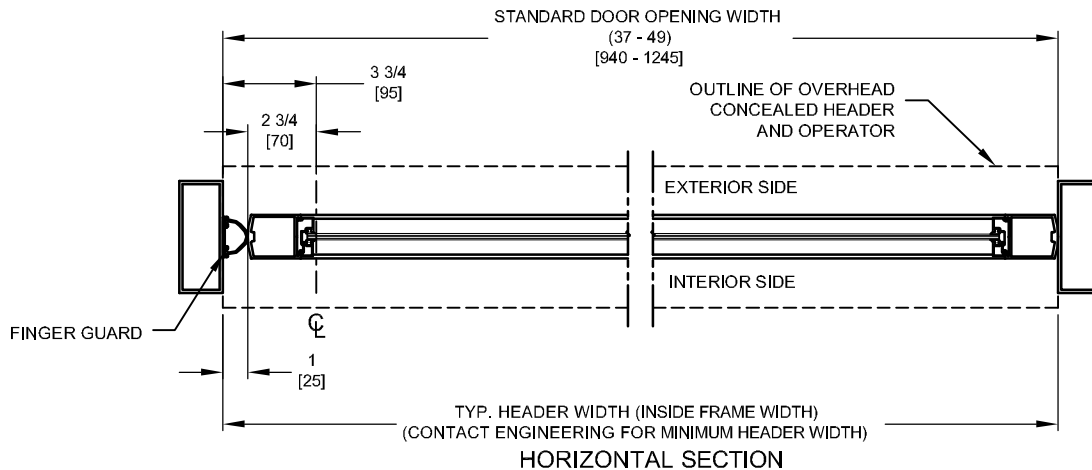

HORIZONTAL SECTION

NOTES:

1. GUIDE RAILS, MATS, PUSH PLATES AND VARIOUS ELECTRONIC DEVICES FOR THE DOOR ACTIVATION AND CONTROL ARE OPTIONAL. CONSULT WITH YOUR NABCO/GYRO TECH DISTRIBUTOR.
2. POWER TO HEADER WILL BE 115VAC, 5 AMP PER OPERATOR PROVIDED BY ELECTRICAL CONTRACTOR.
3. STANDARD HARDWARE SUPPLIED WILL ACCOMMODATE DOOR THICKNESS OF 1 3/4" TO 2 1/4".