

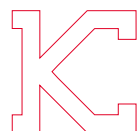

EXTENDO®

Telescopic doors



KLEIN



EXTENDO 3

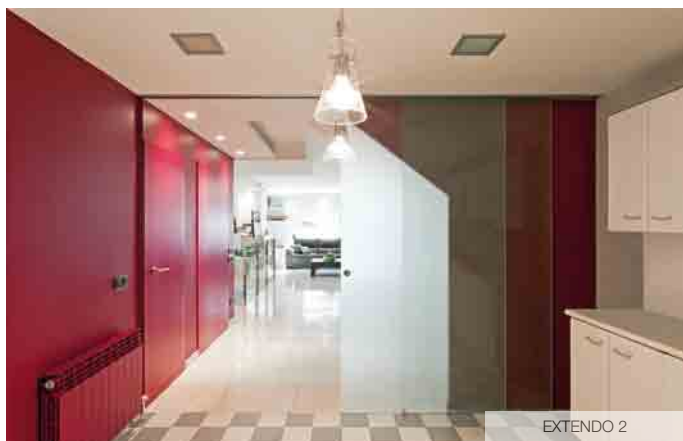

EXTENDO 2



EXTENDO CORNER

ENG

Extendo® is a telescopic door system designed to divide space through simultaneous sliding frameless glass doors providing a large opening with a minimal storing space.

- Ideal for conference rooms, offices, kitchen, bedroom entrances, etc.
- Innovative system for high end projects leaving a clear opening up to 16'-8".
- Synchronized opening system of 2, 3 or 4 doors.
- Clean opening free of floor tracks.
- Glass panels held through high weight capacity pressure clamps with no glass drillings (use of tempered or laminated glass).
- Use of 3/8" and 1/2" glass panels up to 10' high.
- Pre-mounted and pre-tensed belt for a quicker and easier assembly.
- "Silver" anodized aluminium profile (AA10 ISO 7599, 10 microns).
- Ball bearing system for quiet and soft opening.
- Wall, ceiling and dropped ceiling mounted.

Systems tested up to 100.000 cycles as per European standard EN1527.

ESP

Extendo® está diseñado para dividir ambientes mediante un sistema de paneles de vidrio telescópico y sincrónico generando una luz de paso mayor con una zona de aparcamiento reducida.

- Ideal para dividir espacios instalándolo en cocinas, salones, habitaciones, oficinas, salas de conferencia...
- Sistema innovador para proyectos contemporáneos buscando abrir espacios amplios hasta 16'-8".
- Sistema de apertura sincronizada de 2, 3 o 4 puertas.
- Zona de paso limpia sin riel en el suelo.
- Sujeción de la puerta mediante mordazas a presión sin mecanización del cristal (vidrio templado o laminado).
- Vidrio de 3/8" o 1/2".
- Sistema de transmisión premontado y pretensado para un montaje rápido.
- Perfil de aluminio anodizado "Silver" (AA10 ISO 7599, 10 micras).
- Rodamientos de bolas para apertura suave.
- Instalación a pared, a techo, o falso techo.

Sistemas testados hasta 100.000 ciclos según la norma EN1527.

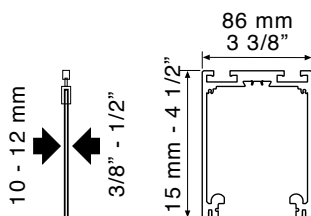
EXTENDO®

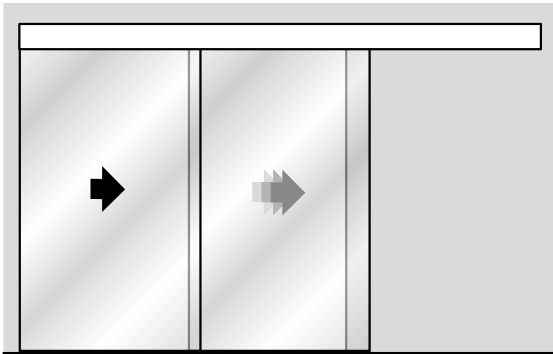
CLEAR OPENING / LUZ DE PASO

EXTENDO 2

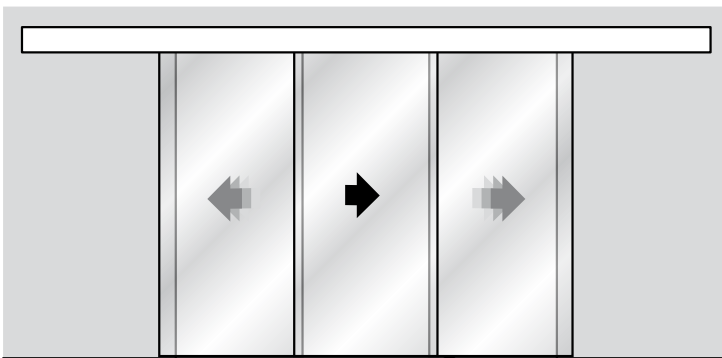
MIN.	MAX.
1.250 mm 4'-1"	2.550 mm 8'-4"

EXTENDO 3

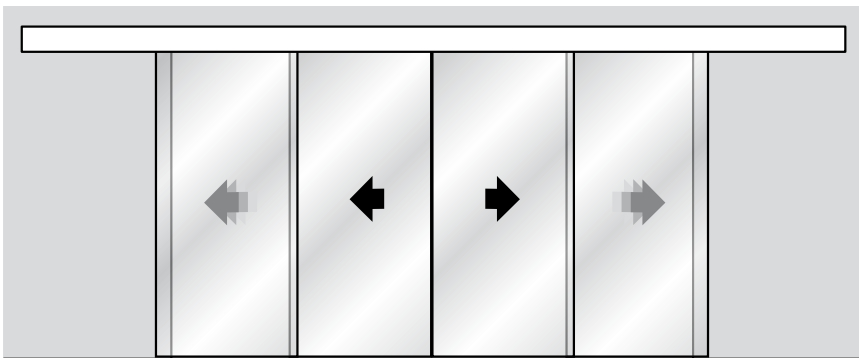
MIN.	MAX.
1.725 mm 5'-8"	2.775 mm 9'-1"

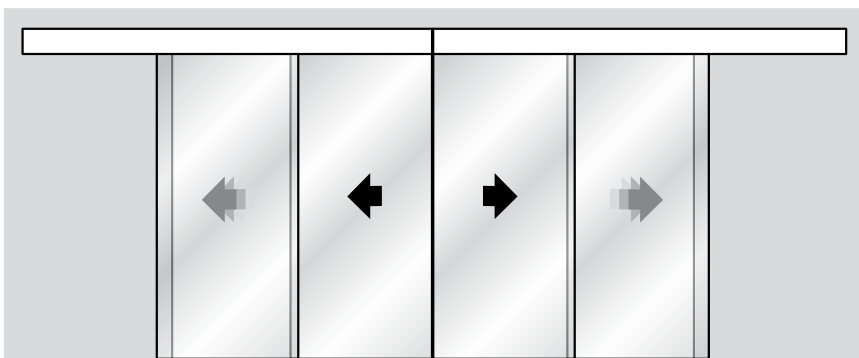

EXTENDO 4

MIN.	MAX.
2.400 mm 7'-10"	3.100 mm 10'-2"

EXTENDO 2+2

MIN.	MAX.
2.500 mm 8'-2"	5.100 mm 16'-8"

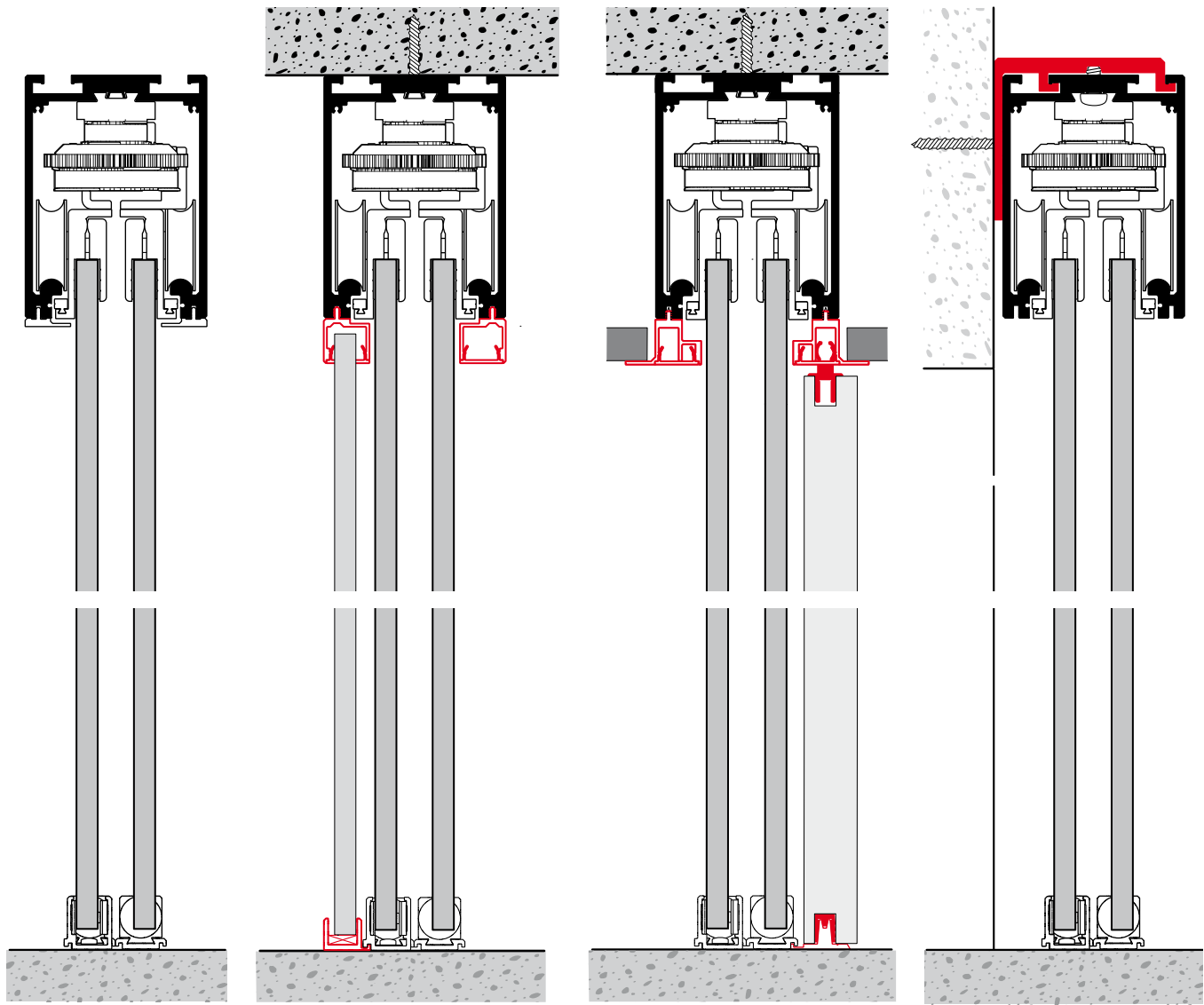
Dimensions in mm are exact. Inches are approximate.



- SLIDING GLASS
PUERTA CORREDERA
- FIXED GLASS
CRISTAL FIJO
- FIXED PANEL
PANEL FIJO
- WALL
PARED
- CEILING
TECHO
- DROPPED CEILING
FALSO TECHO
- FLOOR
SUELO

- Accessories available for diverse combinations of applications. Option of combining fixed glass panels and wood panels.
- Accesorios disponibles para diversas combinaciones de aplicaciones. Posibilidad de combinar paneles fijos de vidrio y de madera.

Dimensions in mm are exact. Inches are approximate.

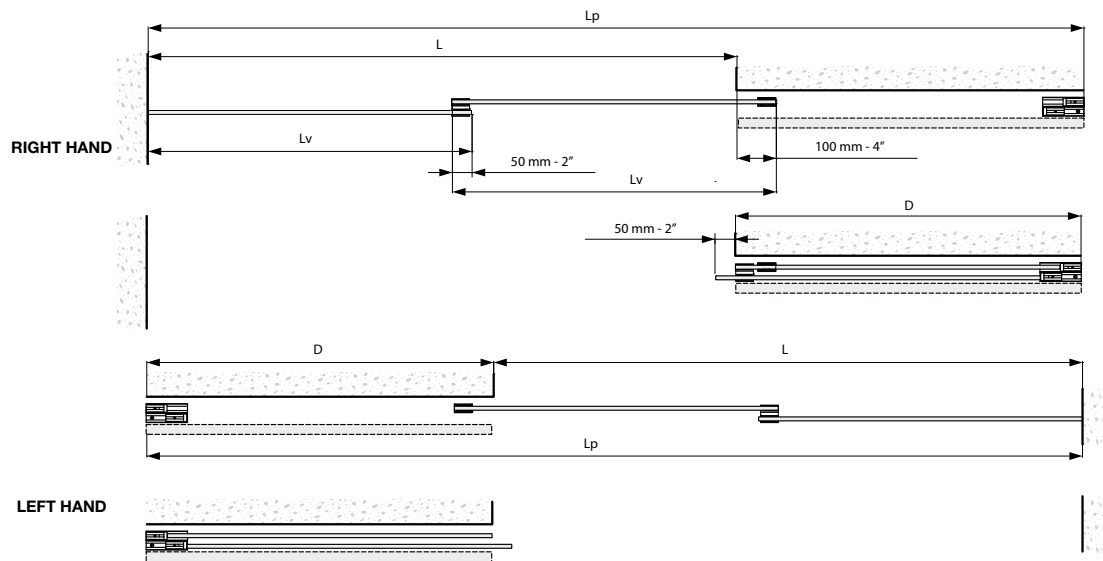
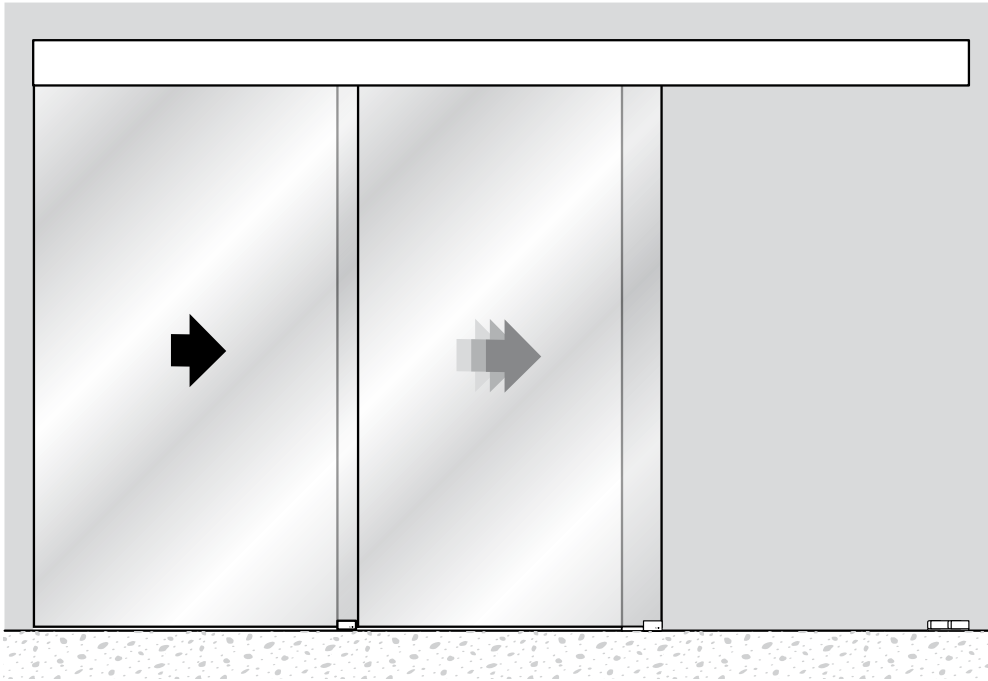
EXTENDO® 2

Ref.	L	Lp	h _v (Height)
G 1	1.250-1.550 mm (4' 1" - 5' 1")	2.500 mm (98")	≤ 3.000 mm (10')
G 2	1.550-1.900 mm (5' 1" - 6' 3")	3.000 mm (118")	≤ 3.000 mm (10')
G 3	1.900-2.200 mm (6' 3" - 7' 3")	3.500 mm (137")	≤ 3.000 mm (10')
G 4	2.200-2.550 mm (7' 3" - 8' 4")	4.000 mm (157")	≤ 2.500 mm (8' 3")

L = _____	$D \geq \frac{1}{2} + 125 \text{ mm (5")}$	Lp = L+D	$Lv = \frac{1}{2} + 75 \text{ mm (3")}$
-----------	--	----------	---

Dimensions in mm are exact. Inches are approximate.

EXTENDO®

EXTENDO® 2

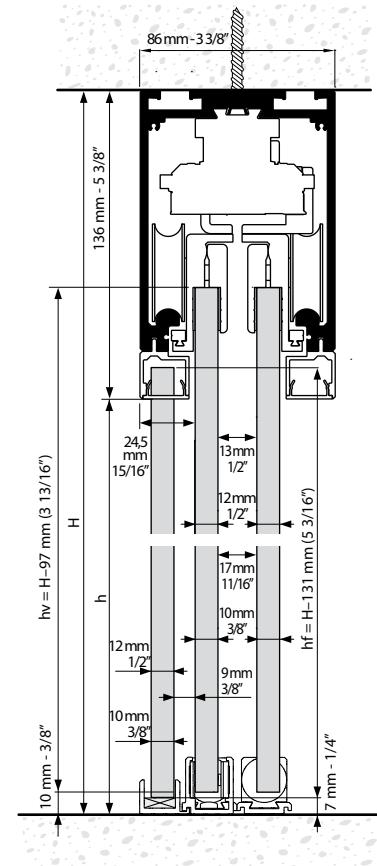
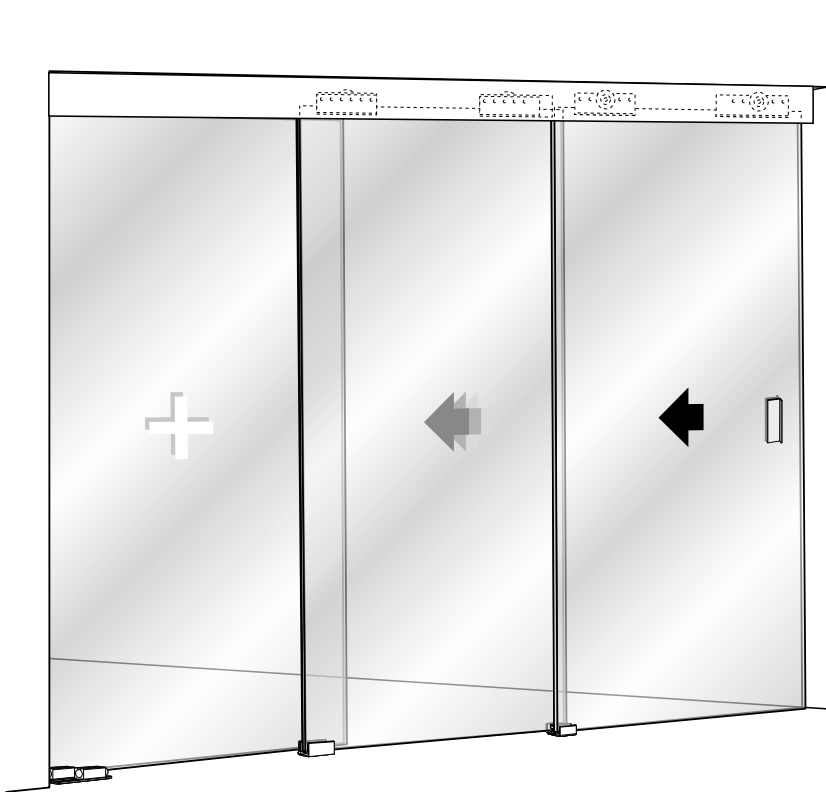
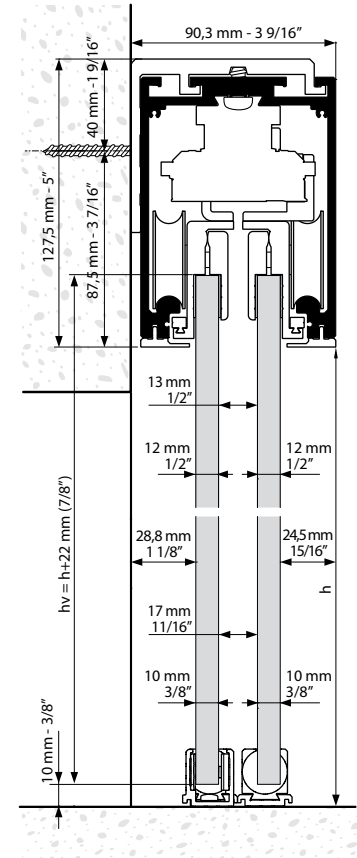
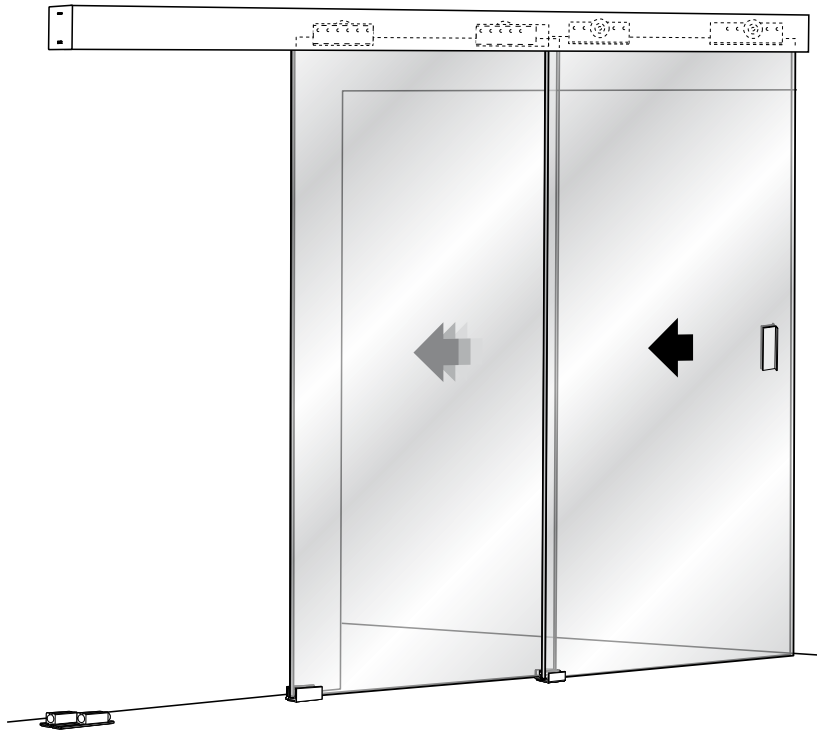

Dimensions in mm are exact. Inches are approximate.

EXTENDO® 3

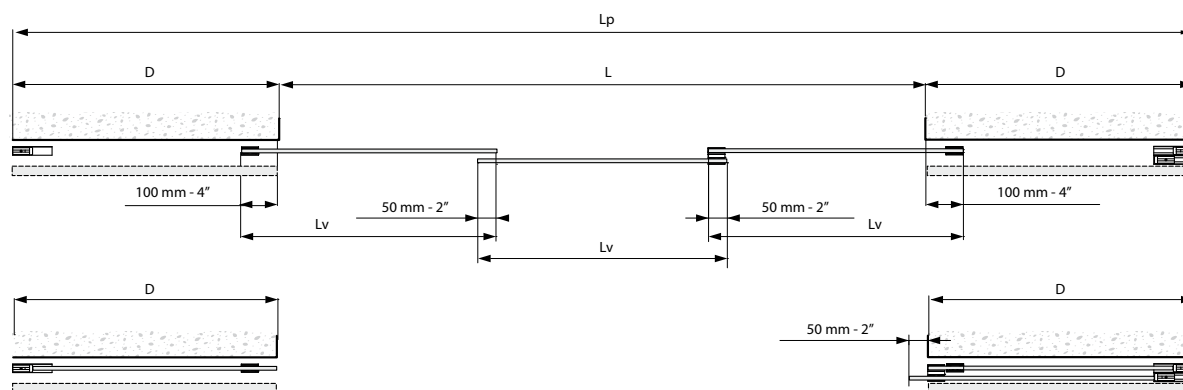
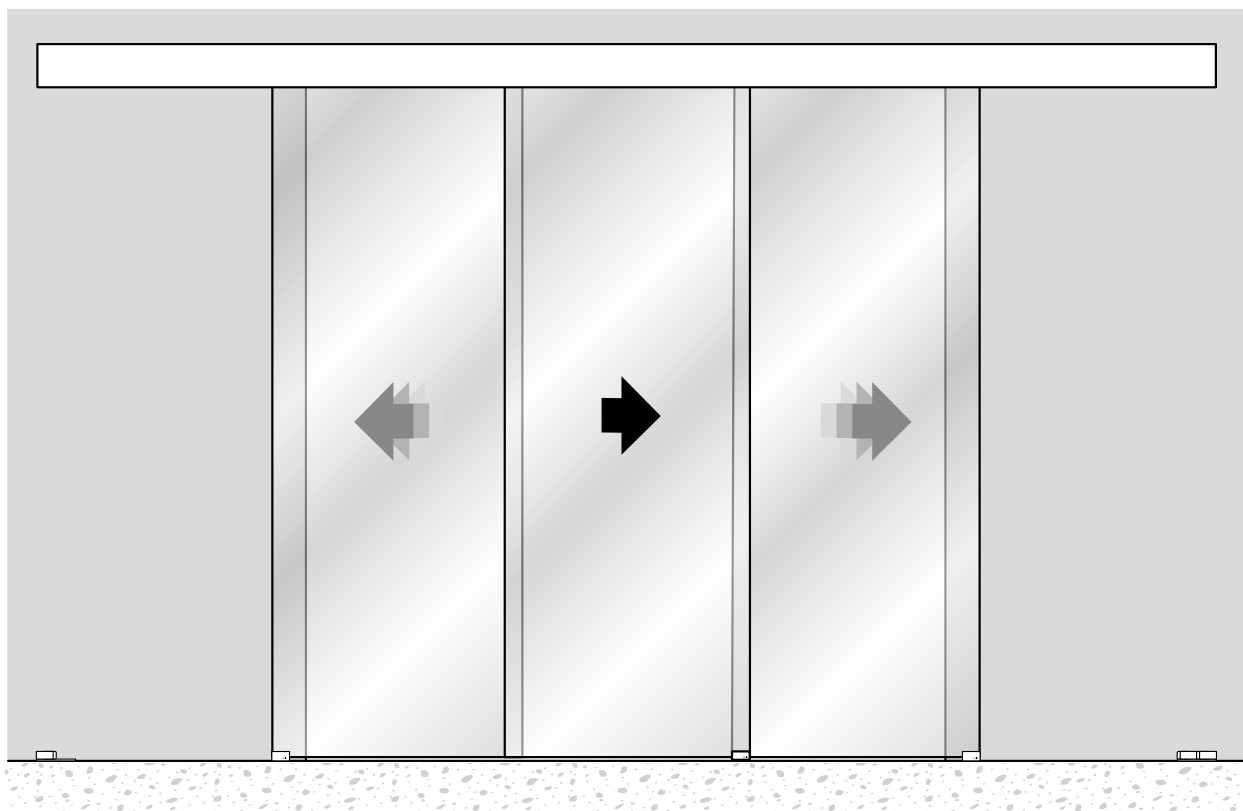

Ref.	L	Lp	hv _(Height)
G 1	1.725-2.175 mm (5' 8" - 7' 2")	4.000 mm (157")	≤ 3.000 mm (10')
G 2	2.175-2.775 mm (7' 2" - 9' 1")	5.000 mm (196")	≤ 2.500 mm (8' 3")
L = _____	$D \geq \frac{L}{3} + 150 \text{ mm (6")}$	$Lp = D \times 2 + L$	$Lv = \frac{L}{3} + 100 \text{ mm (4')}$

Dimensions in mm are exact. Inches are approximate.

EXTENDO®

EXTENDO® 3

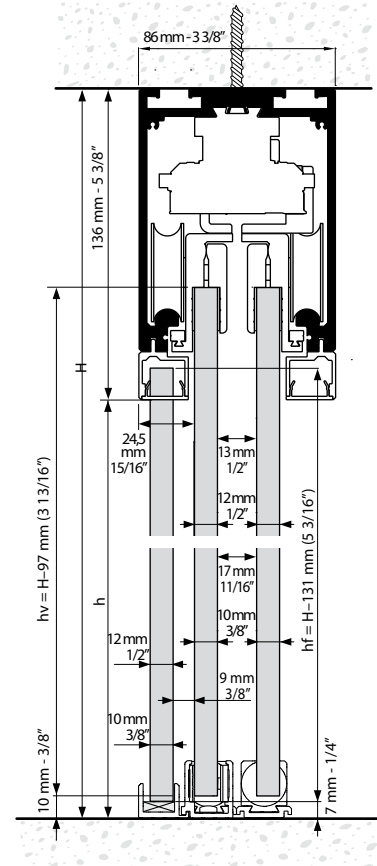
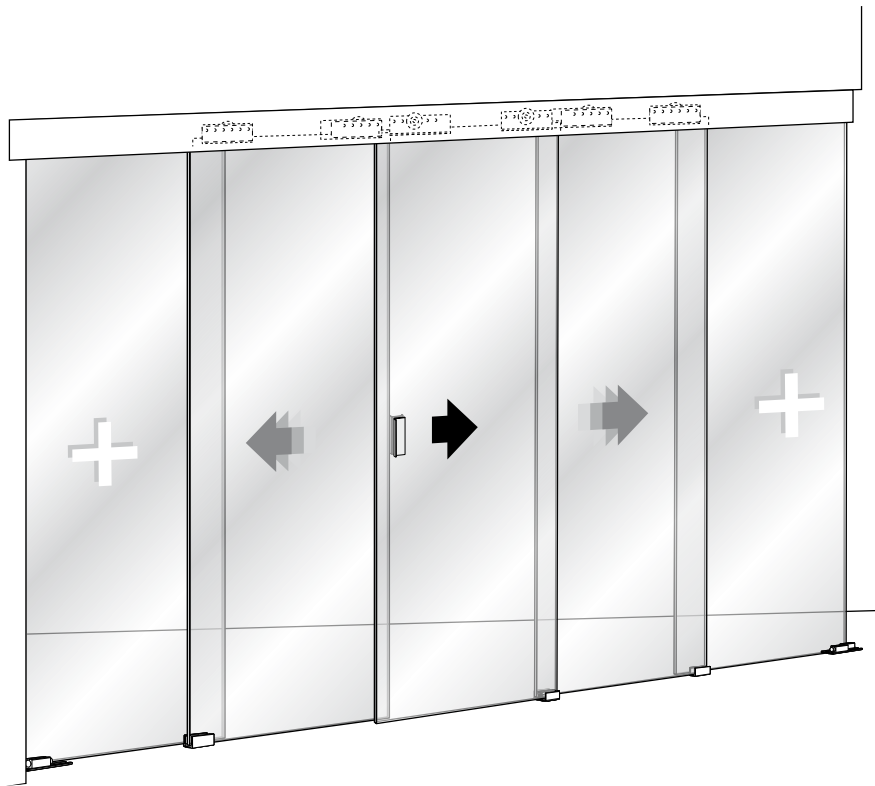
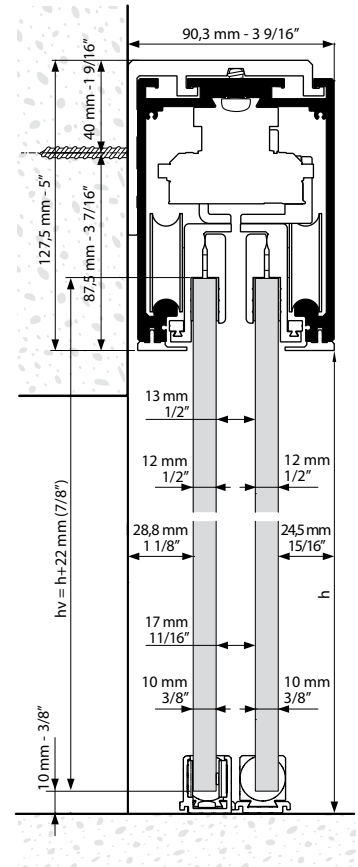
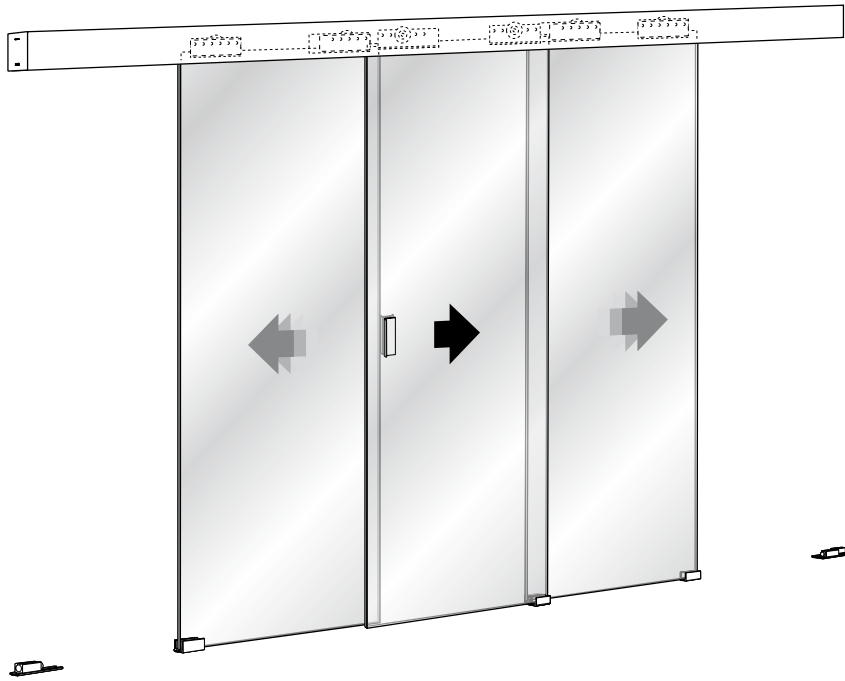

Dimensions in mm are exact. Inches are approximate.

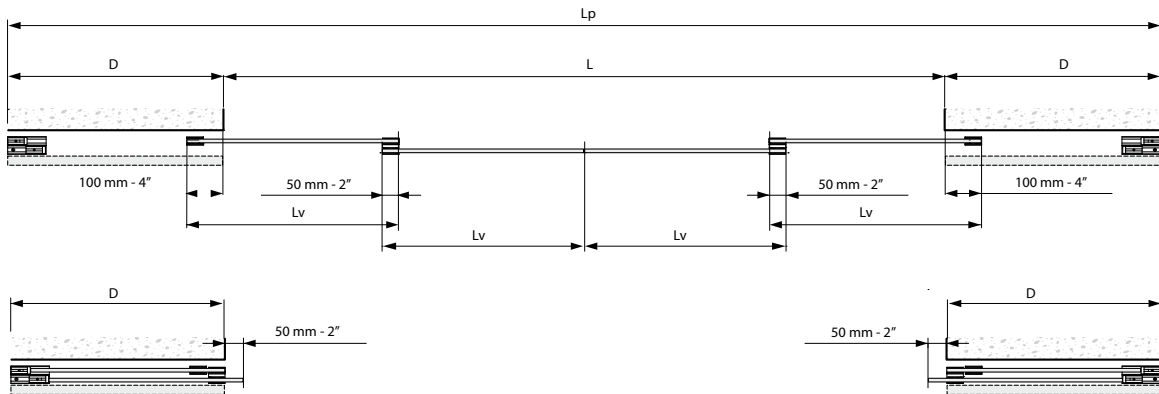
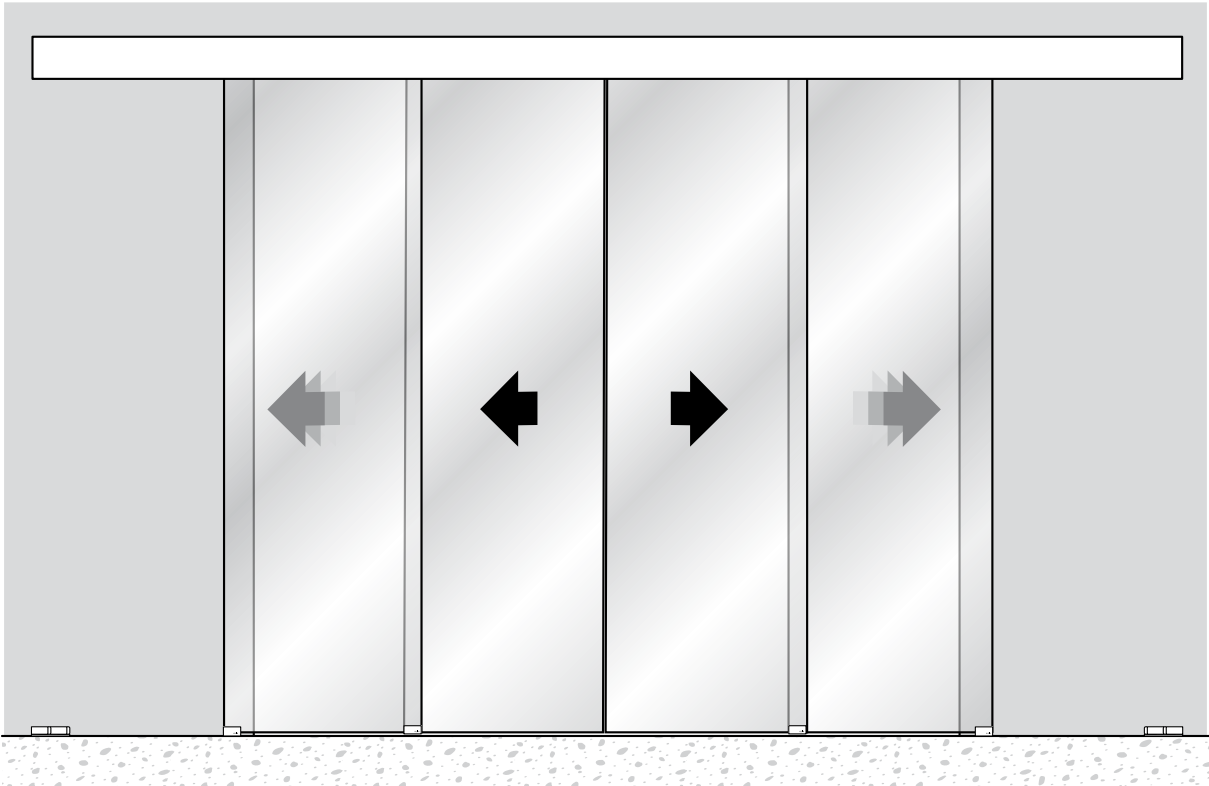
EXTENDO® 4

Ref.	L	Lp	hv
G 1	2.400-3.100 mm (7' 10" - 10' 2")	5.000 mm (196")	≤ 2.500 mm (8' 3")
L = _____	$D \geq \frac{L}{4} + 125 \text{ mm (5")}$	$Lp = Dx2+L$	$Lv = \frac{L}{4} + 75 \text{ mm (3")}$

Dimensions in mm are exact. Inches are approximate.

EXTENDO®

EXTENDO® 4

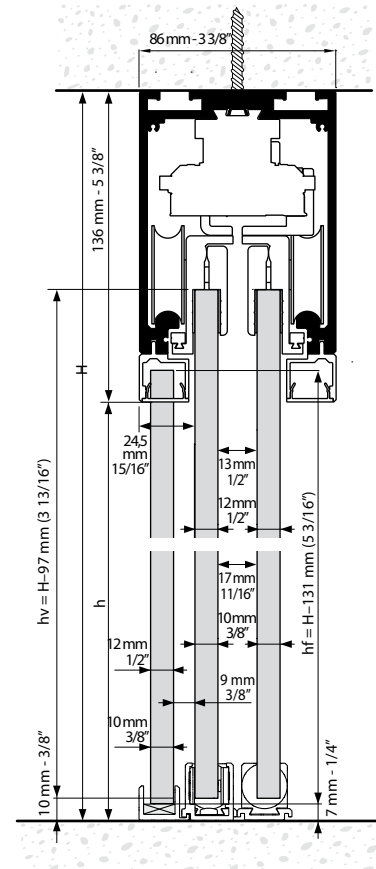
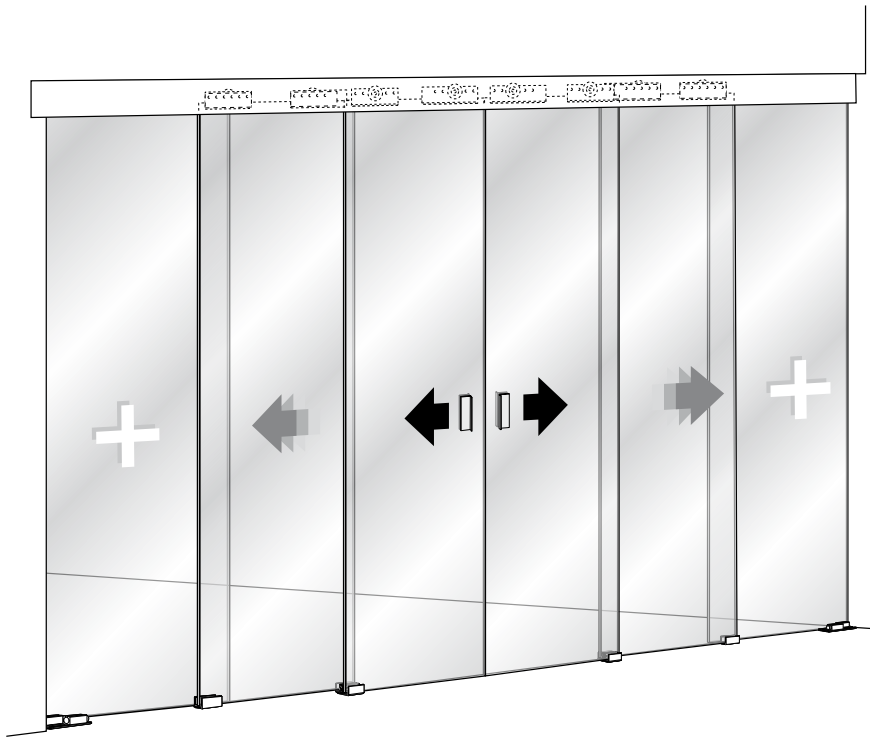
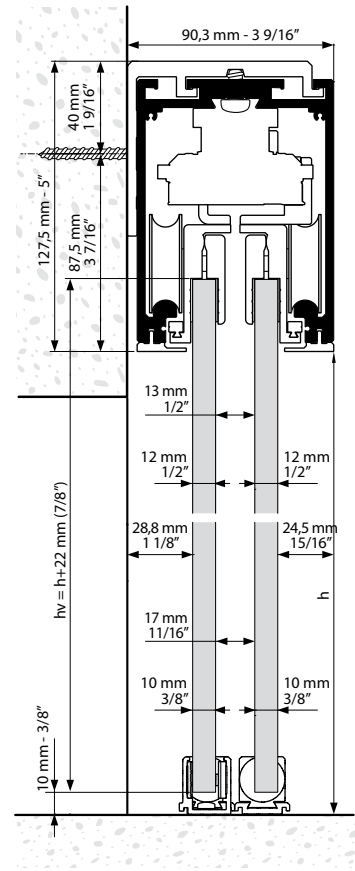
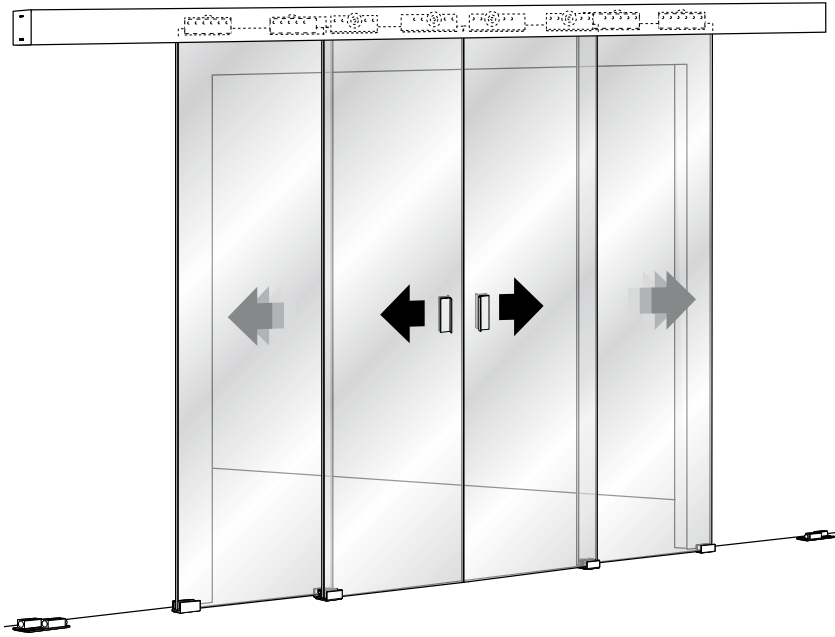

Dimensions in mm are exact. Inches are approximate.

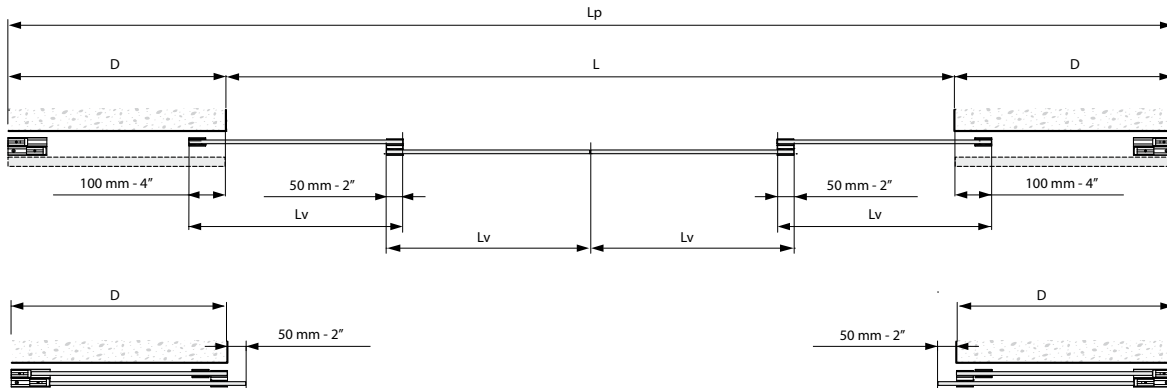
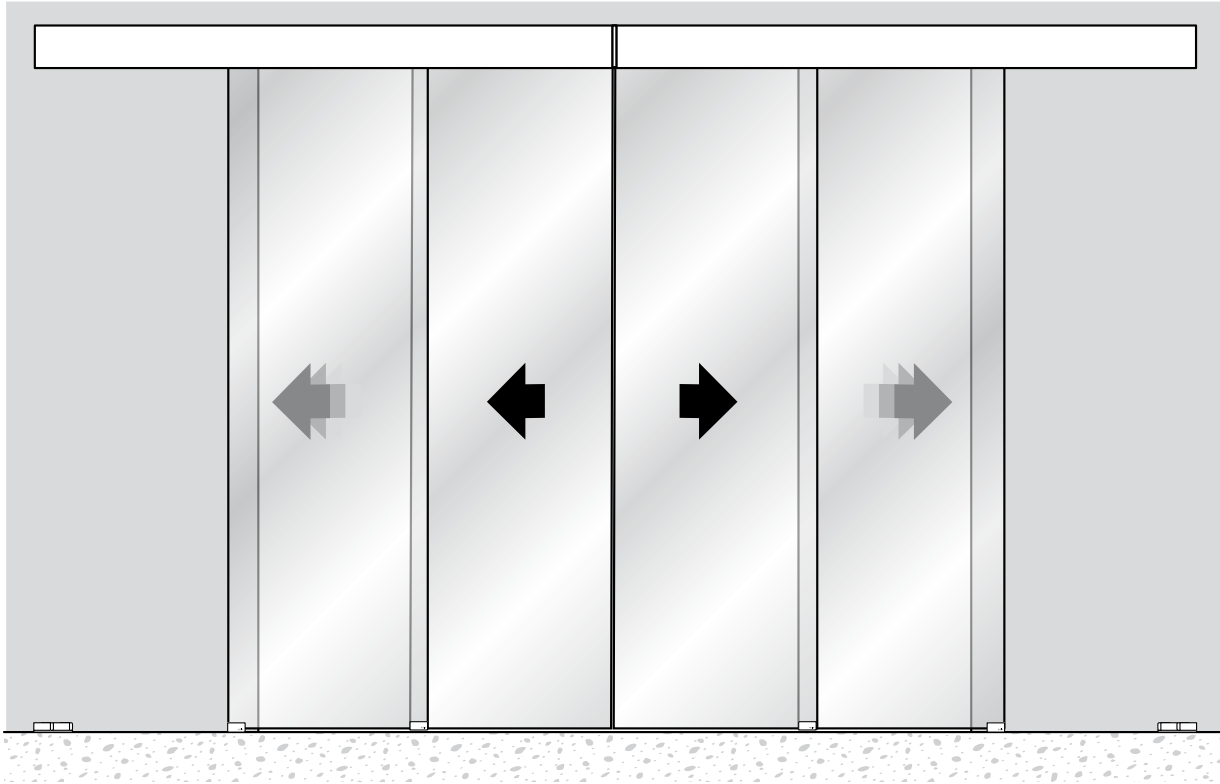
EXTENDO® 2+2

Ref.	L	L _p	h _v (Height)
G 1	2.500-3.100 mm (8' 2" - 10' 2")	2.500 mm (98") x2	≤ 3.000 mm (10')
G 2	3.100-3.800 mm (10' 2" - 12' 6")	3.000 mm (118") x2	≤ 3.000 mm (10')
G 3	3.800-4.400 mm (12' 6" - 14' 5")	3.500 mm (137") x2	≤ 3.000 mm (10')
G 4	4.400-5.100 mm (14' 5" - 16' 9")	4.000 mm (?) x2	≤ 2.500 mm (8' 3")

L = _____	$D \geq \frac{L}{4} + 125 \text{ mm (5")}$	$L_p = D \times 2 + L$	$L_v = \frac{L}{4} + 75 \text{ mm (3")}$
-----------	--	------------------------	--

Dimensions in mm are exact. Inches are approximate.

EXTENDO®

EXTENDO® 2+2

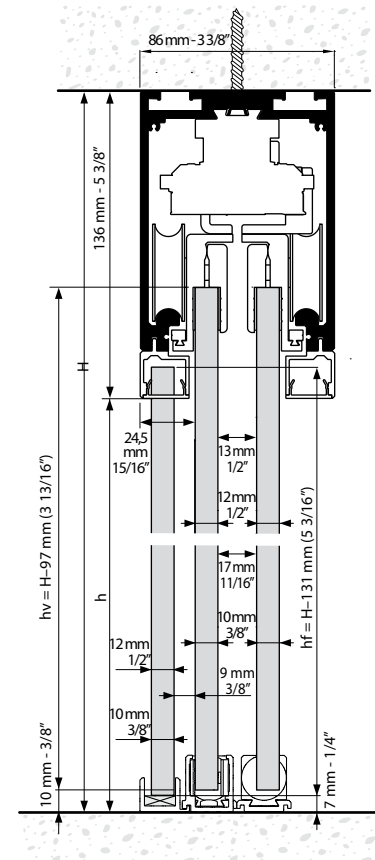
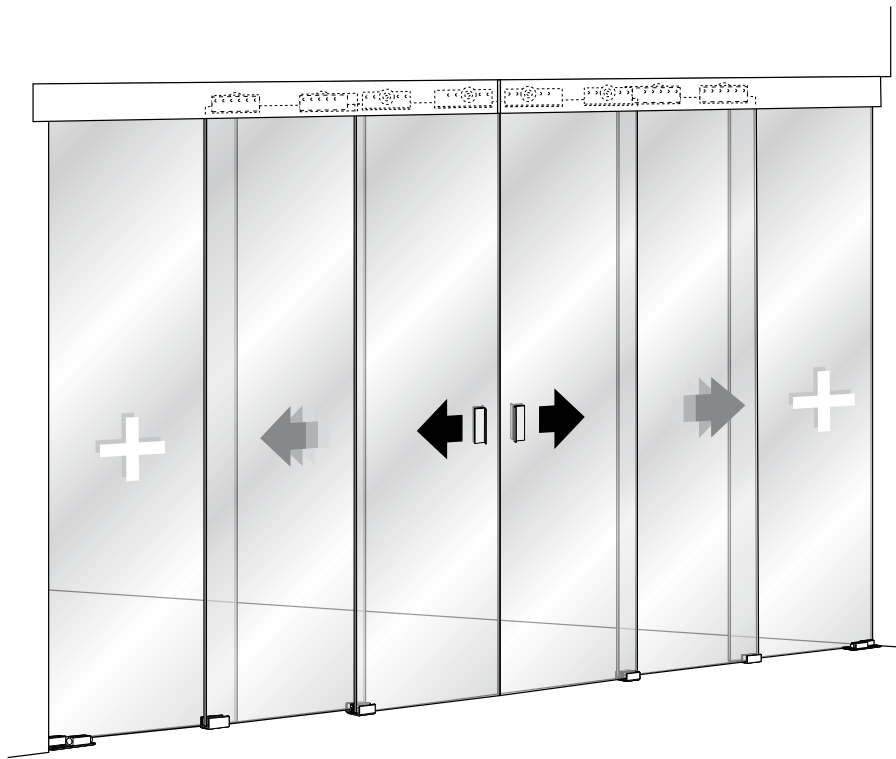
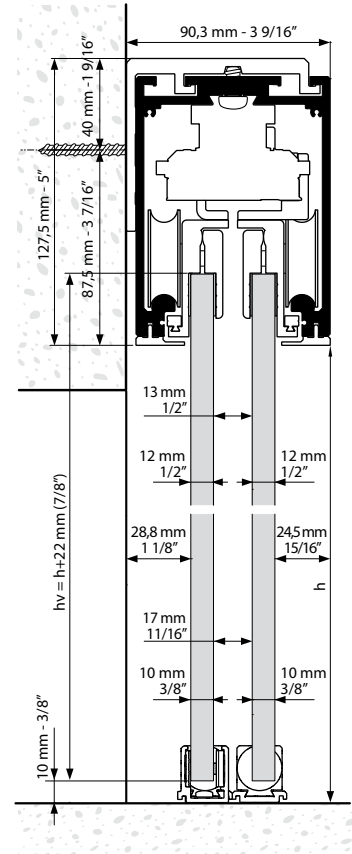
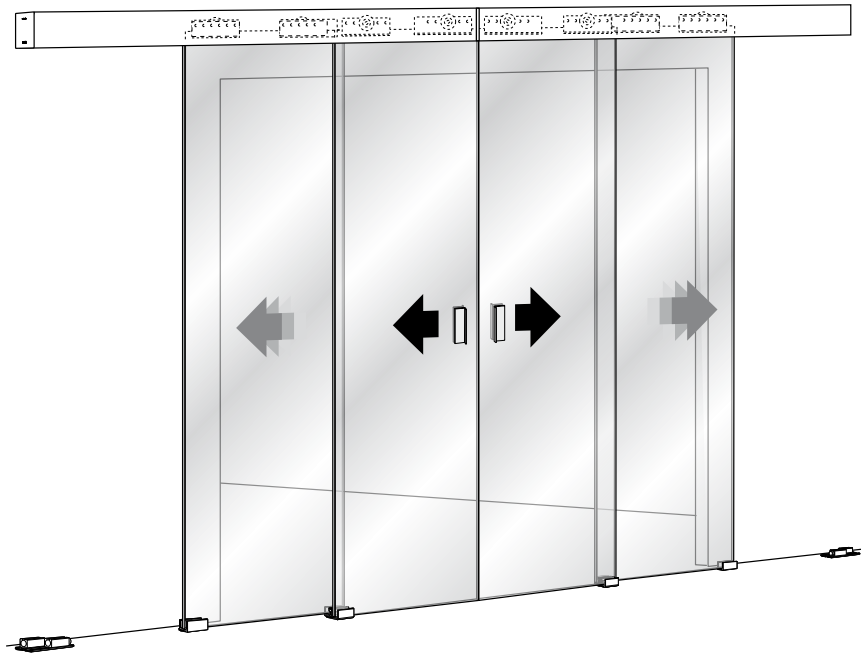

Dimensions in mm are exact. Inches are approximate.



ENG

EXTENDO® - 3/8" Glass		
Ref.	Description	Img.
8111	INST. EXTENDO 2 DOORS, RIGHT, G-1 (3/8" GLASS) 98" TRACK	A
8112	INST. EXTENDO 2 DOORS, RIGHT, G-2 (3/8" GLASS) 118" TRACK	A
8113	INST. EXTENDO 2 DOORS, RIGHT, G-3 (3/8" GLASS) 137" TRACK	A
8114	INST. EXTENDO 2 DOORS, RIGHT, G-4 (3/8" GLASS) 157" TRACK	A
8121	INST. EXTENDO 2 DOORS, LEFT, G-1 (3/8" GLASS) 98" TRACK	A
8122	INST. EXTENDO 2 DOORS, LEFT, G-2 (3/8" GLASS) 118" TRACK	A
8123	INST. EXTENDO 2 DOORS, LEFT, G-3 (3/8" GLASS) 137" TRACK	A
8124	INST. EXTENDO 2 DOORS, LEFT, G-4 (3/8" GLASS) 157" TRACK	A

EXTENDO® - 1/2" Glass		
Ref.	Description	Img.
8116	INST. EXTENDO 2 DOORS, RIGHT, G-1 (1/2" GLASS) 98" TRACK	A
8117	INST. EXTENDO 2 DOORS, RIGHT, G-2 (1/2" GLASS) 118" TRACK	A
8118	INST. EXTENDO 2 DOORS, RIGHT, G-3 (1/2" GLASS) 157" TRACK	A
8126	INST. EXTENDO 2 DOORS, LEFT, G-1 (1/2" GLASS) 98" TRACK	A
8127	INST. EXTENDO 2 DOORS, LEFT, G-2 (1/2" GLASS) 118" TRACK	A
8128	INST. EXTENDO 2 DOORS, LEFT, G-3 (1/2" GLASS) 157" TRACK	A

Additional Components		
Ref.	Description	Img.
1652	WALL FIXING TRACK EXTENDO 118"	B
1654	WALL FIXING TRACK EXTENDO 157"	B
1664	SET OF UPPER TRACKS FOR FIXED GLASS EXTENDO 157"	C
1691	BOTTOM TRACK FOR FIXED GLASS EXTENDO 78"	D
1684	SET UPPER TRACKS FOR FIXED GLASS EXTENDO 157" DROPPED CEILING	E
1693	SET OF SHORT END CAPS FOR EXTENDO TOP TRACK	F
1694	SET OF LONG END CAPS FOR EXTENDO TOP TRACK	G

ESP

EXTENDO® - vidrio 3/8"		
Ref.	Descripción	Img.
8111	INST. EXTENDO 2 PUERTAS, DERECHA, G-1 (VIDRIO 3/8") PERFIL 98"	A
8112	INST. EXTENDO 2 PUERTAS, DERECHA, G-2 (VIDRIO 3/8") PERFIL 118"	A
8113	INST. EXTENDO 2 PUERTAS, DERECHA, G-3 (VIDRIO 3/8") PERFIL 137"	A
8114	INST. EXTENDO 2 PUERTAS, DERECHA, G-4 (VIDRIO 3/8") PERFIL 157"	A
8121	INST. EXTENDO 2 PUERTAS, IZQUIERDA, G-1 (VIDRIO 3/8") PERFIL 98"	A
8122	INST. EXTENDO 2 PUERTAS, IZQUIERDA, G-2 (VIDRIO 3/8") PERFIL 118"	A
8123	INST. EXTENDO 2 PUERTAS, IZQUIERDA, G-3 (VIDRIO 3/8") PERFIL 137"	A
8124	INST. EXTENDO 2 PUERTAS, IZQUIERDA, G-4 (VIDRIO 3/8") PERFIL 157"	A

EXTENDO® - vidrio 1/2"		
Ref.	Descripción	Img.
8116	INST. EXTENDO 2 PUERTAS, DERECHA, G-1 (VIDRIO 1/2") PERFIL 98"	A
8117	INST. EXTENDO 2 PUERTAS, DERECHA, G-2 (VIDRIO 1/2") PERFIL 118"	A
8118	INST. EXTENDO 2 PUERTAS, DERECHA, G-3 (VIDRIO 1/2") PERFIL 157"	A
8126	INST. EXTENDO 2 PUERTAS, IZQUIERDA, G-1 (VIDRIO 1/2") PERFIL 98"	A
8127	INST. EXTENDO 2 PUERTAS, IZQUIERDA, G-2 (VIDRIO 1/2") PERFIL 118"	A
8128	INST. EXTENDO 2 PUERTAS, IZQUIERDA, G-3 (VIDRIO 1/2") PERFIL 157"	A

Accesorios adicionales		
Ref.	Descripción	Img.
1652	SOPORTE PARED EXTENDO 118"	B
1654	SOPORTE PARED EXTENDO 157"	B
1664	JGO. PF. VIDRIO FIJO EXTENDO 157"	C
1691	PF. INF. VIDRIO FIJO EXTENDO 78"	D
1684	JGO. PF. VIDRIO EXTENDO 157" PARA TECHO	E
1693	JGO. TAPAS LATERALES CORTAS	F
1694	JGO. TAPAS LATERALES LARGAS	G

EXTENDO[®]

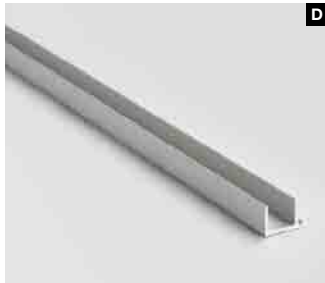



KLEIN USA, Inc.[®]
833 Magnolia Ave.
Elizabeth, NJ 07201
Toll-Free (888) KLEIN US

Phone: 908 994 1111
Fax: 908 994 1119
info@klein-usa.com
www.klein-usa.com

KLEIN

The photos, pictures, contents and products described in this catalogue are for information and guidance purposes only and therefore shall not give rise to any rights or expectations nor constitute a binding sales offer as they are protected by intellectual and industrial property rights in favour of KLEIN IBERICA, S.A.[®] / Las fotografías, imágenes, contenidos y productos descritos en el presente catalogo tienen carácter exclusivamente ilustrativo y orientativo por lo que no originarán derechos ni expectativas de derechos, ni constituyen una oferta comercial vinculante, resultando protegidos por derechos de propiedad intelectual e industrial a favor de KLEIN IBERICA, S.A.[®]