



AL-Series

Cylindrical Locks





Put Your Trust in the Name You Know

For more than 90 years Schlage® has been providing innovative security solutions for schools, hospitals, hotels, condominiums and a host of other commercial buildings. Today, Schlage is at the forefront of cutting-edge technology including wireless security, access control systems including readers, credentials and biometrics. With a wide range of products, styles and finishes, Schlage has what you need no matter how demanding your project specifications may be. And, we stand behind every product we make with the best after-sales service in the business. It's this commitment to design, performance and technology that ensures you can stand behind our products too.

Contents

- 4-5 Mechanical Lock Guide
- 6 AL-Series Introduction and Performance Features
- 7 Exploded View
- 8 Lever Designs
- 9 Lever Finishes and Door Handing
- 10-11 Lock Functions
- 12 Cylinder Types
- 13 Standard Cylinders
- 13 Primus XP High Security Cylinders
- 14 Full Size Interchangeable Core
- 14 Small Format Interchangeable Core
- 15 IC Conversion Kits
- 15 IC Installation Tool
- 16 Latches
- 17 Strikes
- 17 Rabbeted Latch and Strike Kit
- 18 Specifications and Certifications

Pictured here: Saturn lever shown in 626 Satin Chrome

Cover photo: Neptune lever shown in 626 Satin Chrome finish

Be sure to ask your SSC representative to tell you about **Custom Solutions** by Ingersoll Rand Security Technologies. To learn more visit securitytechnologies.ingersollrand.com.



QuietSolutions



CustomDécor



HighSecurity and Safety



EnvironmentalSolutions



FlexibleConfigurations

Real Security is Knowing Exactly What You Want and Getting It





When you know exactly what you want, you don't want to waste time finding out whether it meets your project specifications. That's why we offer the world's largest team of hardware specification writers to help you and your clients turn your vision into reality. And when it comes to products, our commercial suiting options, wide variety of lever designs and rich selection of finishes give you the tools you need to make your projects perfect. You know what you want. With Schlage you can be sure you'll get it.

Safety, Security and Confidence

When you choose a Schlage lock you can be sure you've done the job right the first time. After all, our products are among the most durable and dependable on the market today. Our locks are easy to install, and simple to repair and maintain. That means fewer callbacks for you and total safety and security for your customers.



Schlage Commercial Locks

				
Tubular Interconnected Locks	Tubular Locks	Tubular Interconnected Locks	Cylindrical Locks	Cylindrical Interconnected Locks
CS200-Series	S-Series	S200-Series	A-Series	H-Series
GRADE 2	GRADE 2		GRADE 2	
Security Level:				
ANSI/BHMA Certified A156.2-2003 Exceeds 400,000 ANSI Cycles Medium Traffic	ANSI/BHMA Certified A156.2-2003 Exceeds 400,000 ANSI Cycles Light Traffic	- - Exceeds 400,000 ANSI Cycles Medium Traffic	ANSI/BHMA Certified A156.2-2003 Exceeds 400,000 ANSI Cycles Medium Traffic	- - Exceeds 400,000 ANSI Cycles Medium Traffic
Typical Applications:				
Exterior Interior New Construction Retrofit	- Interior - Retrofit	Exterior Interior New Construction Retrofit	Exterior Interior New Construction Retrofit	Exterior Interior - Retrofit
Functions Available:				
1 Function - -	6 Functions - -	5 Functions - -	11 Functions - -	5 Functions - -
Design Options:				
7 Finishes 15 Lever Styles - 1 Matching Rose 2 Interior Escutcheons Tactile Warning Available	7 Finishes 4 Lever Styles - 1 Matching Rose - Tactile Warning Available	7 Finishes 4 Lever Styles - 1 Matching Rose 1 Interior Escutcheon -	10 Finishes 1 Lever Style 4 Knob Styles 1 Matching Rose - -	7 Finishes 1 Lever Style 2 Knob Styles 1 Matching Rose 1 Interior Escutcheon -
Often Used In:				
Commercial Multi-Family Office	Commercial Multi-Family Office	Commercial Multi-Family Office	Commercial Govt/Military Healthcare Hospitality Office Retail	Commercial Govt/Military Multi-Family

Not all functions and finishes available with all products. Please consult your SSC representative for details.



Cylindrical Locks



Deadbolts



Cylindrical Locks



Cylindrical Locks



Mortise Locks

AL-Series	B-Series		D-Series	ND-Series	L-Series
GRADE 2	GRADE 2	GRADE 1	GRADE 1	GRADE 1	GRADE 1
Security Level:					
ANSI/BHMA Certified A156.2-2003 Exceeds 400,000 ANSI Cycles Medium Traffic	ANSI/BHMA Certified A156.5-2001 Exceeds 150,000/250,000 ANSI Cycles High Traffic Heavy Duty		ANSI/BHMA Certified A156.2-2003 Exceeds 800,000 ANSI Cycles High Traffic	ANSI/BHMA Certified A156.2-2003 Exceeds 800,000 ANSI Cycles Heavy Duty Traffic	ANSI/BHMA Certified A156.13-2005 Exceeds 1,000,000 ANSI Cycles Heavy Duty Traffic
Typical Applications:					
Exterior Interior New Construction Retrofit	Exterior - New Construction Retrofit		Exterior Interior - Retrofit	Exterior Interior New Construction Retrofit	Exterior Interior New Construction Retrofit
Functions Available:					
10 Functions - -	7 Functions	6 Functions - -	14 Functions 2 Electrified -	29 Functions 6 Electrified Vandgard® Available	49 Functions 4 Electrified Vandgard® Available
Design Options:					
10 Finishes 4 Lever Styles - 1 Matching Rose - Tactile Warning Available	10 Finishes - - - Indicator Rose		10 Finishes - 3 Knob Styles 1 Matching Rose - -	9 Finishes 5 Lever Styles - 2 Matching Roses - Tactile Warning Available	13 Finishes 26 Lever Styles 3 Knob Styles 4 Matching Roses 2 Escutcheons Tactile Warning Available Antilgrature Available
Often Used In:					
Commercial Healthcare Hospitality Office Retail	Commercial/Institutional Govt/Military Heavy Duty Residential Hospitality Office Retail		Institutional Govt/Military Hospitality Retail	Institutional Education Healthcare Office Retail	Institutional Education Healthcare Office

This chart shows the most common uses/applications and these products are often used in other applications in addition to those listed.

AL-Series

Dependable performance for high traffic commercial applications.

At Schlage we know that every product you specify has to stand up to constant use, while meeting your needs for security at every level. Our AL-Series locks are designed to deliver ADA compliant accessibility and constant, reliable performance. The AL-Series is best for buildings with medium to high traffic flow, such as interior office doors, banks, retail spaces and hotel guest areas. With a Grade 2 ANSI rating, and styles and finishes to suit your building's design, the AL-Series fits right where you need it.

Pictured here: Jupiter lever shown in 626 Satin Chrome



We don't compromise on security.

The safety and security of your clients' buildings is something we take very seriously. That's why every Schlage lock and deadbolt undergoes intensive testing to determine its ANSI grade level:

- Cycle tests
- Resistance tests
- Door impact tests
- Warped door tests
- Bolt strength tests

We pay attention to these details so you can focus on creating a functional and aesthetically pleasing environment for your clients. In fact, every one of our AL-Series locks meets ANSI Grade 2 standards for safety.

The lever that looks as good as it performs.

- Cold-rolled steel, machined and threaded hubs, and locking nuts prevent loosening of the lockset by securely bolting chassis to the door
- Large diameter of mounting plate and rose covers new ANSI hollow metal door cutout
- Patented door range adjuster allows quick and easy adjustment for doors ranging from 1 3/8" to 1 7/8" (35 mm to 48 mm) thick

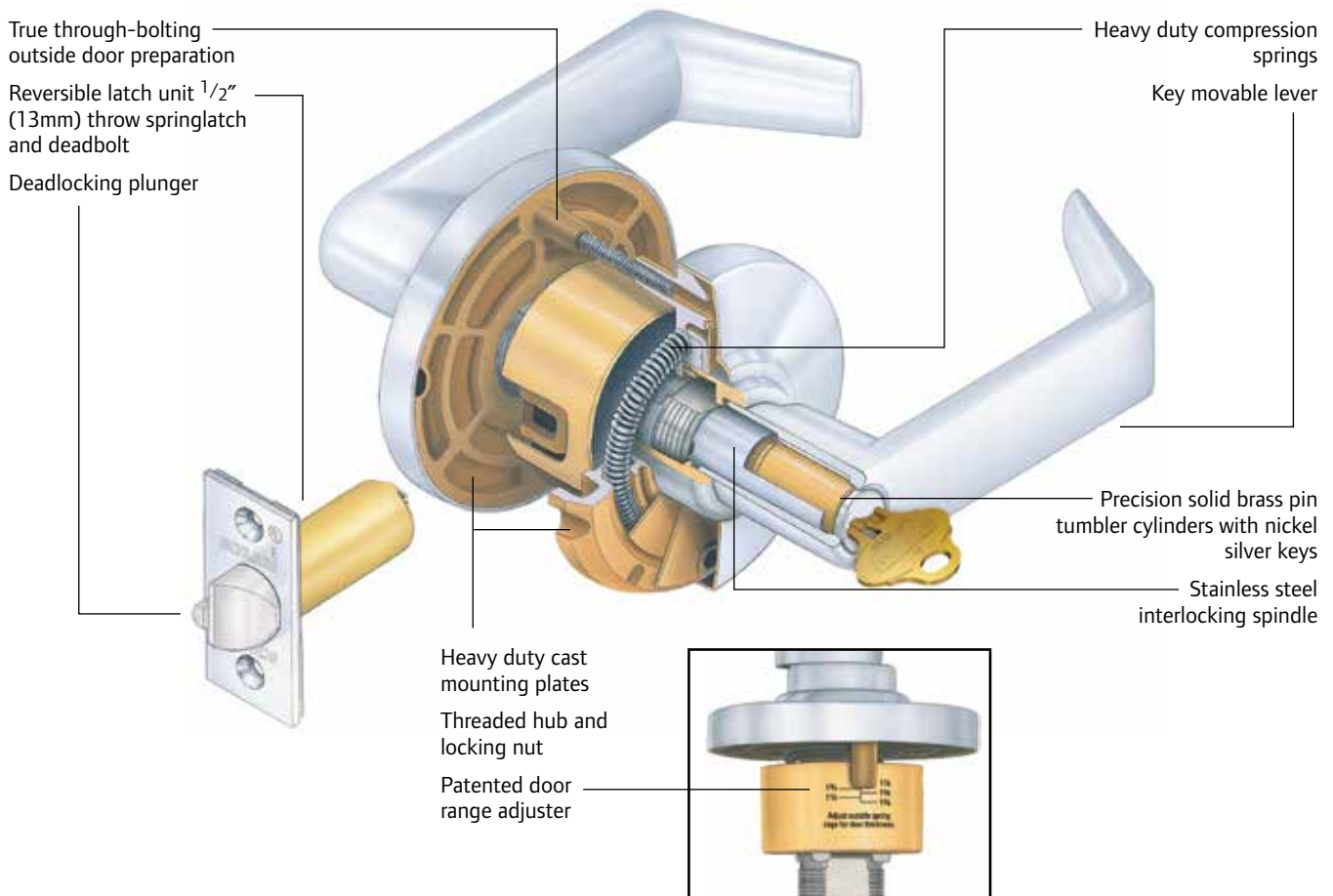

AL Series Lever Designs

Jupiter (JUP)



Symbol: JUP
Material: Pressure cast zinc lever; wrought brass or bronze rose
Suites: S-Series **JUPITER**, ND-Series **ATHENS** and L-Series **07** designs



Neptune (NEP)



Symbol: NEP
Material: Pressure cast zinc lever; wrought brass or bronze rose
Suites: S-Series **NEPTUNE**, ND-Series **SPARTA** and L-Series **17** designs



Omega (OME)



Symbol: OME
Material: Pressure cast zinc lever; wrought brass or bronze rose
Suites: ND-Series **OMEGA** and L-Series **OMEGA** designs



Saturn (SAT)



Symbol: SAT
Material: Pressure cast zinc lever; wrought brass or bronze rose
Suites: S-Series **SATURN**, H-Series **LEVON**, ND-Series **RHODES** and L-Series **06** designs

Options: Tactile Warning



Tactile Warning

Milled

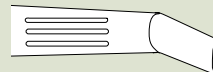

Order as follows:
8SA for Saturn

Only available on outside lever, unless otherwise specified

All designs shown in 626 Satin Chrome

	= Standard cylinder.		= Antimicrobial coating available on 626 finish only.
	= FSIC - Full size interchangeable core option.		= Meets California code for 1/2" or less return to the door.
	= SFIC - Small format interchangeable core option.		= Extended factory lead time.
	= Complies with ADA Accessibility Guidelines.		

Lever Finishes



AL SERIES LOCKS										
Jupiter	•	•		•	•	•	•	•	•	•
Neptune	•	•	•	•	•	•	•	•	•	•
Omega	•	•	•	•	•	•	•	•	•	•
Saturn	•	•	•	•	•	•	•	•	•	•

e = an equivalent finish to the BHMA standard.

Door Handing

All Schlage locks are reversible. Hand information is necessary to ensure proper cylinder orientation in keyed functions, and finish of latchbolt and strike for locks that are to be installed on reverse bevel doors. Follow the diagram to correctly determine the hand of the door.

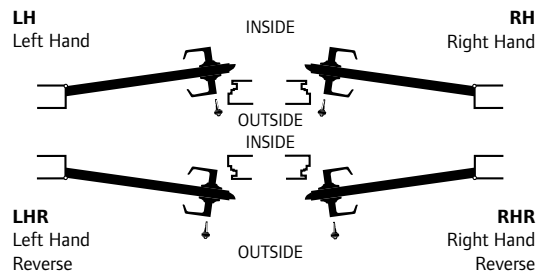

ADA-Compliant Products

In compliance with the American National Standards Institute (ANSI A117.1) and the Americans with Disabilities Act (ADA), Schlage Lock Company offers a wide selection of locks designed for the needs of the physically challenged. This act is designed to provide protection for people with disabilities.

The intent of ADA is that owners of certain types of buildings must remove barriers and provide people with disabilities with access equal to, or similar to, that available to the general public.

Product information and specifications contained in this catalog are subject to change without notice. Please consult the factory.

Lock Functions | ANSI A156.2 Series 4000 Grade 2

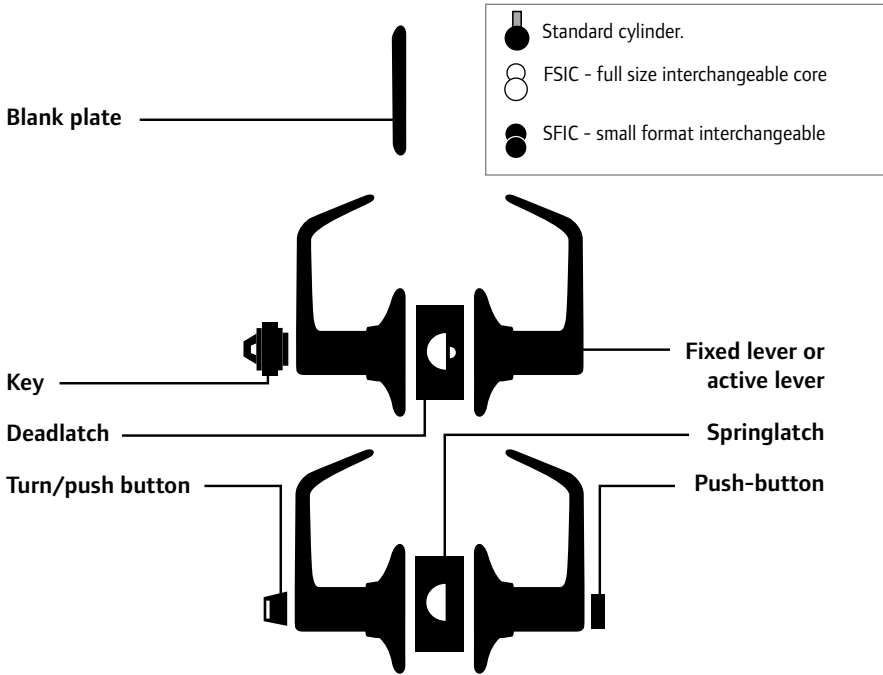

Non-Keyed Functions

SCHLAGE	ANSI
AL105	F75

Passage Latch

- Both levers always unlocked.
- Inside lever always free for immediate egress.

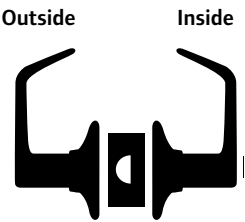

SCHLAGE	ANSI
AL25D	-

Exit Lock

- Blank plate outside.
- Inside lever always unlocked.
- Inside lever always free for immediate egress.
- Specify door thickness.

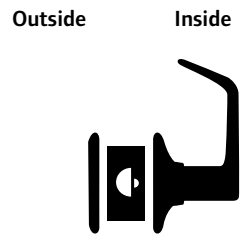

SCHLAGE	ANSI
AL40S	F76

Bath/Bedroom Privacy Lock

- Push-button locking.
- Can be unlocked from outside with small screwdriver.
- Turn inside lever or close door to release button.
- Inside lever always free for immediate egress.

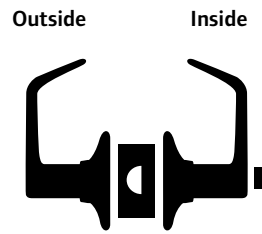

SCHLAGE	ANSI
AL44S	-

Hospital Privacy Lock

- Push-button locking.
- Unlock from outside by turning emergency turn-button.
- Turn inside lever or close door to release button.
- Inside lever always free for immediate egress.

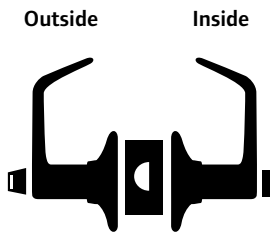

Lock Functions | ANSI A156.2 Series 4000 Grade 2

Keyed Functions

SCHLAGE ANSI

AL170 -

Single Dummy Trim

- Single dummy trim for one side of door.
- Used for door pull or as matching inactive trim.

Outside or Inside



SCHLAGE ANSI

AL50PD F82

Entrance/Office Lock

- Push-button locking.
- Push-button locks outside lever until it is unlocked with a key or by rotating the inside lever.
- Inside lever always free for immediate egress.

Outside Inside

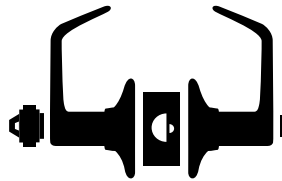

SCHLAGE ANSI

AL53PD F109

Entrance Lock

- Turn/push-button locking: Pushing and turning button locks outside lever, requiring use of a key until the button is manually unlocked.
- Push-button locking: Push-button locks the outside lever until it is unlocked by key or by turning the inside lever.
- Inside lever always free for immediate egress.

Outside Inside

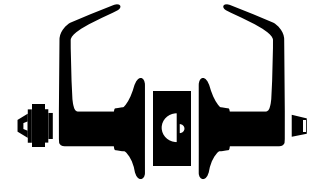

SCHLAGE ANSI

AL70PD F84

Classroom Lock

- Outside lever is locked and unlocked by key.
- Inside lever is always unlocked.
- Inside lever always free for immediate egress.

Outside Inside

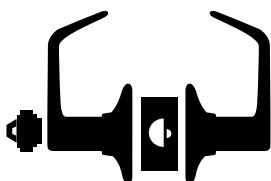

SCHLAGE ANSI

AL80PD F86

Storeroom Lock

- Outside lever is fixed.
- Entrance by key only.
- Inside lever is always unlocked.
- Inside lever always free for immediate egress.

Outside Inside

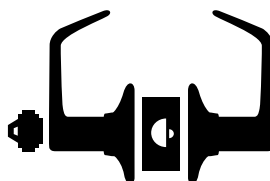

SCHLAGE ANSI

AL85PD F93

Faculty Restroom Lock (with Indicator Cylinder)

- Outside lever is fixed.
- Entrance by key only.
- Push button on inside lever activates visual occupancy indicator, allowing only the emergency masterkey to operate.
- Rotate inside lever or close door to release visual occupancy indicator.
- Rotation of inside spanner button provides lockout feature by keeping indicator thrown.
- Inside lever always free for immediate egress.

Outside Inside

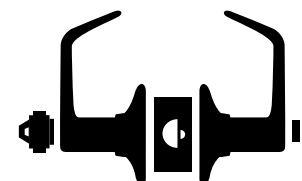

Cylinders and Key Systems

Protect New Key Systems with Everest 29

Schlage can help you design a system that can grow and change along with your needs, allowing you the flexibility to upgrade your security without the need to replace all your cylinders.

What it operates	What it is
<ul style="list-style-type: none"> Everest 29 Primus® XP cylinders Everest 29 restricted cylinders Everest 29 open cylinders 	UL 437 Version <ul style="list-style-type: none"> UL 437 versions provide drill and pick resistance and withstand physical attack High security cylinders have a second set of pins for added security <ul style="list-style-type: none"> Patented key control sold with various levels of geographic exclusivity Keys operate high security, as well as restricted security or standard security cylinders Available only in conventional and FSIC

What it operates	What it is
<ul style="list-style-type: none"> Everest 29 Primus XP cylinders Everest 29 restricted cylinders Everest 29 open cylinders 	Controlled Access <ul style="list-style-type: none"> Patented key control sold with various levels of geographic exclusivity High security cylinders have a second set of pins for added security and pick resistance <ul style="list-style-type: none"> Keys operate high security, as well as restricted security or standard security cylinders Available only in conventional and FSIC

What it operates	What it is
<ul style="list-style-type: none"> Everest 29 restricted cylinders 	<ul style="list-style-type: none"> Key distribution is restricted—duplication must be authorized End user's ID numbers are stamped on all keys, enabling Schlage to identify the source of any unauthorized keys Patent-protected keys are drop-shipped from the factory directly to an end-user specified location to guarantee exclusivity Available in conventional, SFIC and FSIC

What it operates	What it is
<ul style="list-style-type: none"> Everest 29 open cylinders 	<ul style="list-style-type: none"> Patented key blanks can be stored by commercial locksmiths and security dealers Keys can be duplicated without any paperwork or signature verification Sold only through commercial outlets Available in conventional and FSIC



EVEREST 29[™] PRIMUS XP
HIGH SECURITY



EVEREST 29[™]
RESTRICTED SECURITY



EVEREST 29[™]
STANDARD SECURITY

Upgrade Existing Classic Key Systems with Primus XP

Schlage offers key system solutions that are ideal for upgrading an existing key system to control key management. Our patent-protected cylinders help prevent unauthorized duplication and can be integrated into virtually any existing system.

What it is	What it operates
UL 437 Version <ul style="list-style-type: none"> UL 437 versions provide drill and pick resistance and withstand physical attack High security cylinders have a second set of pins for added security <ul style="list-style-type: none"> Patented key control sold with various levels of geographic exclusivity Keys operate high security, as well as restricted security or standard security cylinders Available only in conventional and FSIC 	<ul style="list-style-type: none"> Primus XP cylinders Classic cylinders

What it is	What it operates
Controlled Access <ul style="list-style-type: none"> Patented key control sold with various levels of geographic exclusivity High security cylinders have a second set of pins for added security and pick resistance <ul style="list-style-type: none"> Keys operate high security, as well as restricted security or standard security cylinders Available only in conventional and FSIC 	<ul style="list-style-type: none"> Primus XP cylinders Classic cylinders

What it is	What it operates
CLASSIC BASIC SECURITY	<ul style="list-style-type: none"> Keys can be duplicated at most retail and commercial points of sale with no restrictions Recommended only for residential applications or existing commercial systems that cannot rekey Can be upgraded to Primus XP without rekeying the entire facility Available in conventional and FSIC



PRIMUS XP
HIGH SECURITY



CLASSIC
BASIC SECURITY

Standard Cylinders

Standard cylinders are available in Classic keyways or in patented Everest 29 keyways.

Specify keyway to differentiate between Everest 29 and Classic.

Example: C (Classic) vs. S123 (Everest 29).

Standard Cylinders - Options

- Conventional 6-Pin cylinder (standard)
- Primus high security cylinder
- Primus UL437 Listed high security cylinder
- Conventional 6-Pin AL85 function with occupancy indicator

Available 606 and 626 finish only. Everest 29 S123 keyway standard.



Example of lock with cylinder for Most Functions



AL85 Cylinder with Occupancy Indicator

Primus XP Access Control and High Security Cylinders

Primus XP access control and high security cylinders are available to add patented key control and varying degrees of geographical exclusivity to most Schlage 6-pin key systems, whether Everest 29 or Classic keyways.

In addition to a conventional pin tumbler mechanism, Primus cylinders incorporate a patented finger pin and sidebar design providing a “dual-locking” cylinder that is virtually pick-proof. Resistance to drilling and other physical attack is optional by specifying 20-500 Series UL437 Listed cylinders.

Classic Primus XP cylinders are recommended for upgrading existing Classic key systems. Due to its extended patent life, the newly designed Everest 29 Primus XP is recommended for new key systems and for upgrading existing Everest key systems. Specify keyway to differentiate between Everest 29 and Classic. Example: C or CP (Classic) vs. S123 (Everest 29).

Visit SecurityTechnologies.IngersollRand.com for more information.

Full Size Interchangeable Core 8 Small Format Interchangeable

Core 8

Schlage interchangeable core (IC) locksets allow immediate rekeying at the door simply by using the special control key to replace the core in seconds.

IC locksets are available in Saturn design only.

The SFIC version is designed for Schlage Everest 29 R Family restricted keyway cores and is also completely compatible with Best®, Falcon and other competitive small format cores.

Full Size Core

Small Format Core



FSIC can be integrated into any 5 or 6-pin Schlage key system.

Small Format Interchangeable Cores - Options (For BD Suffix Locksets)



- 7-Pin uncombined Everest 29 R Family restricted keyways
- 7-Pin combined Everest 29 R Family restricted keyways
- 6-pin uncombined Falcon / Best keyways
- 7-pin uncombined Falcon / Best keyways
- Disposable plastic construction core

Full Size Interchangeable Cores - Options (For JD Suffix Locksets)

Available 606 and 626 finish only. Specify keyway for existing systems.

- Conventional core
- Primus XP high security core

Available 606 and 626 finish only. Specify keyway for existing systems.

80-033 and 80-043 cores are available in A, D, E, F, G, H, J, K, L, and M keyways.

80-036 and 80-037 restricted keyway cores require a letter of authorization from the end user. Schlage assigns the keyway when establishing new Everest 29 restricted key systems.

Available 606 and 626 finish only. Everest 29 S123 keyway standard.

IC Conversion Kits

It is easy to convert standard AL Series locksets to accept Schlage full size interchangeable cores by changing the lever and adding the parts shown.

Conversion to SFIC requires different components, as well as dismantling the lockset to replace internal parts. No kits are available for this purpose.

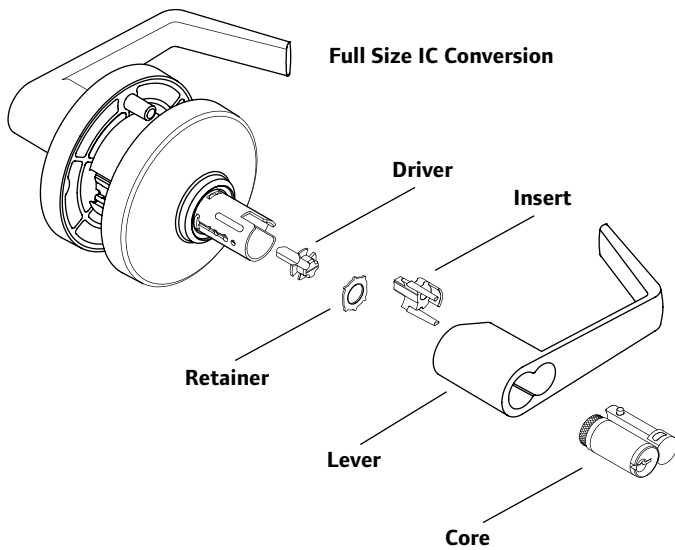

Interchangeable Core Components - Options

- Conversion kit: Driver, retainer, lever, core *
- Conversion kit: Driver, retainer, lever
- Driver, retainer
- Lever only (Saturn)*
- IC Installation Tool

*Specify finish.

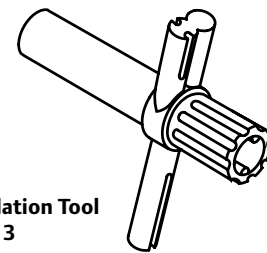

Latches

AL-Series latches are adjustable for flat or beveled edge doors. Latches and strikes are furnished in brass, bronze, or chrome finishes compatible with lock trim. When ordering separately, specify quantity, part number, and finish. Standard latches shown in bold type.

Latches

Backset	Faceplate Description	Hsg Dia	Deadlatch 1/2" (13 mm) Throw	Springlatch 1/2" (13 mm) Throw
2 3/8" (60 mm)	1" x 2 1/4" (25 mm x 57 mm) square corner	7/8" (22 mm)	11-085	11-068
	1" x 2 1/4" (25 mm x 57 mm) 1/4" (6 mm) radius round corner	7/8" (22 mm)	11-088	11-069
	1" (25 mm) circular drive-in (non-U.L.) 605 and 626 finishes only	1" (25 mm)	11-104	11-110
2 3/4" (70 mm)	1" x 2 1/4" (25 mm x 57 mm) square corner	7/8" (22 mm)	11-091	11-111
	1 1/8" x 2 1/4" (29 mm x 57 mm) square corner, standard	1" (25 mm)	11-096	11-116
	1" x 2 1/4" (25 mm x 57 mm) 1/4" (6 mm) radius round corner 605 and 626 finishes only	7/8" (22 mm)	11-092	11-112
	1" (25 mm) circular drive-in (non-U.L.)	1" (25 mm)	11-105	11-113
3 3/4" (95 mm)	1 1/8" x 2 1/4" (29 mm x 57 mm) square corner	1" (25 mm)	11-103	11-118
5" (127mm)	Backset Extension link*	7/8" (22 mm)	41-005*	

*Backset extension link 41-005 must be used with 2 3/8" backset latches.

Square Corner Latches

Springlatch

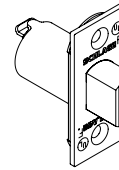

Deadlatch

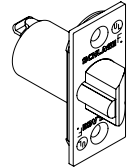

Round Corner Latches

Springlatch

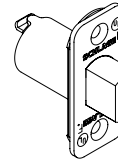

Deadlatch

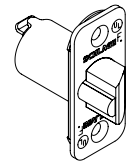

Drive-In Latches

Springlatch

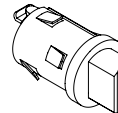

Deadlatch

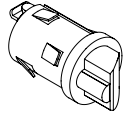

Long Backsets

Backsets 5" require extension links. AL-Series locks with long backsets are normally furnished with 1" faceplates and 7/8" housings. Links installed in 1" latch holes require one G506-815 sleeve (order separately) to join latch and link.

5" Extension Link

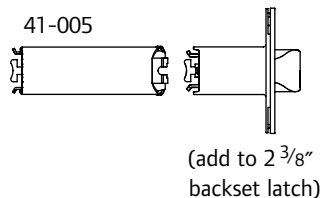

Sleeve
G506-815
(Order separately)



Latch Front Adapter

A501-878

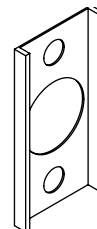

Used to convert 1" wide square front faceplates for 1 1/8" wide door preparations. Furnished in black plastic. Order in units of 100 each.

Door Reinforcement

Reinforcing unit is required to reinforce and help prevent the collapse of hollow metal doors when locksets are tightly mounted. This kit should be used with long backsets for AL-Series lock installations in hollow metal doors to prevent lateral movement of the latchbolt. Specify door thickness, 1³/₈" (35 mm) or 1³/₄" (44 mm), when ordering reinforcement kits.

Reinforcement Kit 37-001

Kit Includes:

Reinforcement

A501-566 for 1³/₄" doors or
A501-565 for 1³/₈" doors

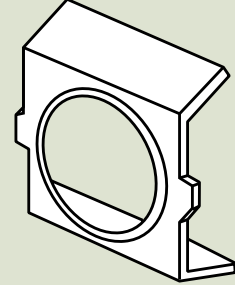

Strikes

All Schlage strikes are furnished complete with screws. The 10-025 standard AL-Series strike has a 1³/₁₆" (30 mm) lip. Standard strikes shown in bold type.

ANSI Strike – Standard
10-025
1¹/₄" x 4⁷/₈" x 3³/₃₂"
(32 mm x 124 mm x 2 mm)

T-Strike
10-001
1¹/₈" x 2³/₄" x 3³/₃₂"
(29 mm x 70 mm x 2 mm)

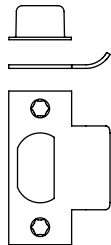
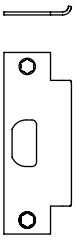

Strikes

Number	Lip Length	Description
10-001	1", 1 ¹ / ₈ " (std), 1 ¹ / ₄ ", 1 ¹ / ₂ ", 1 ³ / ₄ ", 2" (25 mm, 29 mm, 32 mm, 38 mm, 44 mm, 51 mm)	1 ¹ / ₈ " x 2 ³ / ₄ " (29mm x 70mm) Square corner, box, standard
10-004	1 ¹ / ₈ " (29mm)	1 ¹ / ₈ " x 2 ³ / ₄ " (29mm x 70mm) 1 ¹ / ₈ " (3mm) Radius, round cnr.
10-025	1³/₁₆", 1³/₈" (30mm, 35mm)	1¹/₄" x 4⁷/₈" (32mm x 124mm) ANSI
10-026	1 ¹ / ₈ " (29mm)	1 ⁵ / ₈ " x 2 ¹ / ₄ " (41mm x 57mm) Full lip, square corner
10-027	1 ¹ / ₈ " (29mm)	1 ⁵ / ₈ " x 2 ¹ / ₄ " (41mm x 57mm) Full lip, 1 ¹ / ₄ " (6mm) radius, round corner
10-058	1 ³ / ₃₂ " (31mm)	1 ³ / ₄ " (44mm) Circular, adjustable
K510-066	—	Box for ANSI Strike

*Use with 2³/₄" square corner strikes only.

Rabbeted Latch and Strike Kit

Rabbeted latch and strike kit finishes: 606, 626. This kit adapts square corner latches and strikes for 1¹/₂" (13 mm) rabbeted door and frame preparations.

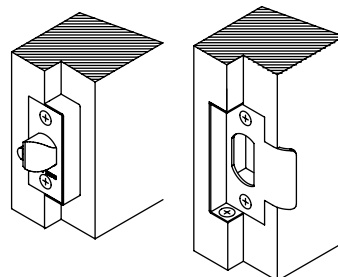

Rabbeted Latch and Strike Kit
39-030

Specifications

Handing:

Non-handed.

Door Thickness:

1³/₈" to 1⁷/₈" (35 mm to 48 mm) standard.

2" (51 mm) optional.

Backset:

2³/₄" (70 mm) standard. 2³/₈" (60 mm), 3³/₄" (95 mm) and 5" (127 mm) optional.

Front:

Steel. 2¹/₄" x 1¹/₈" square corner, beveled, for 2³/₄" backset standard. Optional 1" square corner, 1" radius corner, and non-UL drive-in / round face. For availability with specific backsets, see page 16.

Lock Chassis:

Steel, zinc dichromated for corrosion resistance

Latch Bolt:

Brass, chrome plated, 1/2" throw, deadlocking on keyed and exterior functions.

Exposed Trim:

Wrought brass and bronze. Levers are pressure cast zinc, plated to match finish symbols.

Strike:

ANSI curved lip strike 4⁷/₈" x 1¹/₄" x 1¹/₄" lip to center standard. Optional strikes, lip lengths and ANSI wrought strike box available. See page 17.

Cylinder & Keys:

6-pin patented Everest 29 S123 keyway standard with two nickel silver keys per lock.

Keying Options:

Interchangeable core and Primus® high security cylinders. Master keying, grand master keying, and construction keying.

Warranty:

Three-year limited.

Certifications

ANSI:

Meets or exceeds A156.2 Series 4000, Grade 2 strength and operational requirements.

Meets A117.1 Accessibility Code.

Federal:

Meets FF-H-106C.

California State Reference Code:

(Formerly Title 19, California State Fire Marshal Standard)

All levers with a return to door of 1/2" (64mm) or less comply.

UL / cUL:

All locks listed for A label single doors, 4' x 8'.

Letter F and UL symbol on latch front indicate listing.

UL437 Listed locking cylinder optional: specify Primus 20-500 Series cylinder.

ADA Compliant:

Schlage Lock Company offers a wide selection of locks designed to meet the Americans With Disabilities Act.





Ingersoll Rand (NYSE:IR) advances the quality of life by creating and sustaining safe, comfortable and efficient environments. Our people and our family of brands—including Club Car®, Ingersoll Rand®, Schlage®, Thermo King® and Trane®—work together to enhance the quality and comfort of air in homes and buildings; transport and protect food and perishables; secure homes and commercial properties; and increase industrial productivity and efficiency. Schlage is the leader in security devices, trusted for 90 years, spanning both the commercial and residential markets. Ingersoll Rand is a \$14 billion global business committed to a world of sustainable progress and enduring results.



securitytechnologies.ingersollrand.com

ingersollrand.com